

JBC

www.jbctools.com

INSTRUCTION MANUAL



PHS Rework Adjustable Arm

Ref. RWS-D

Packing List

The following items are included:

Tool Arm 1 unit



Base 1 unit



Screw 1 unit
Ref. 0017057



Allen key 1 unit
Ref. 0013609



Adapters 1 unit
Ref. 0017058 (for JT-TA Heater)
0017059 (for TE-TB Precision Heater)



Manual 1 unit
Ref. 0022696



Features

Ideal for working with JBC's Hot Air stations and a Preheater, especially the PHSE-KA.

Tool Holder

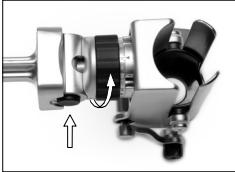

Adjust the tool head holder position according to your work needs

Hose Clamp



Vertical axis with ruler

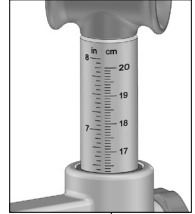

Turn the lever to lower the tool

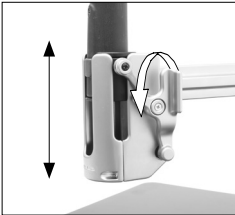

When you have finished raise the tool to free up the workspace.

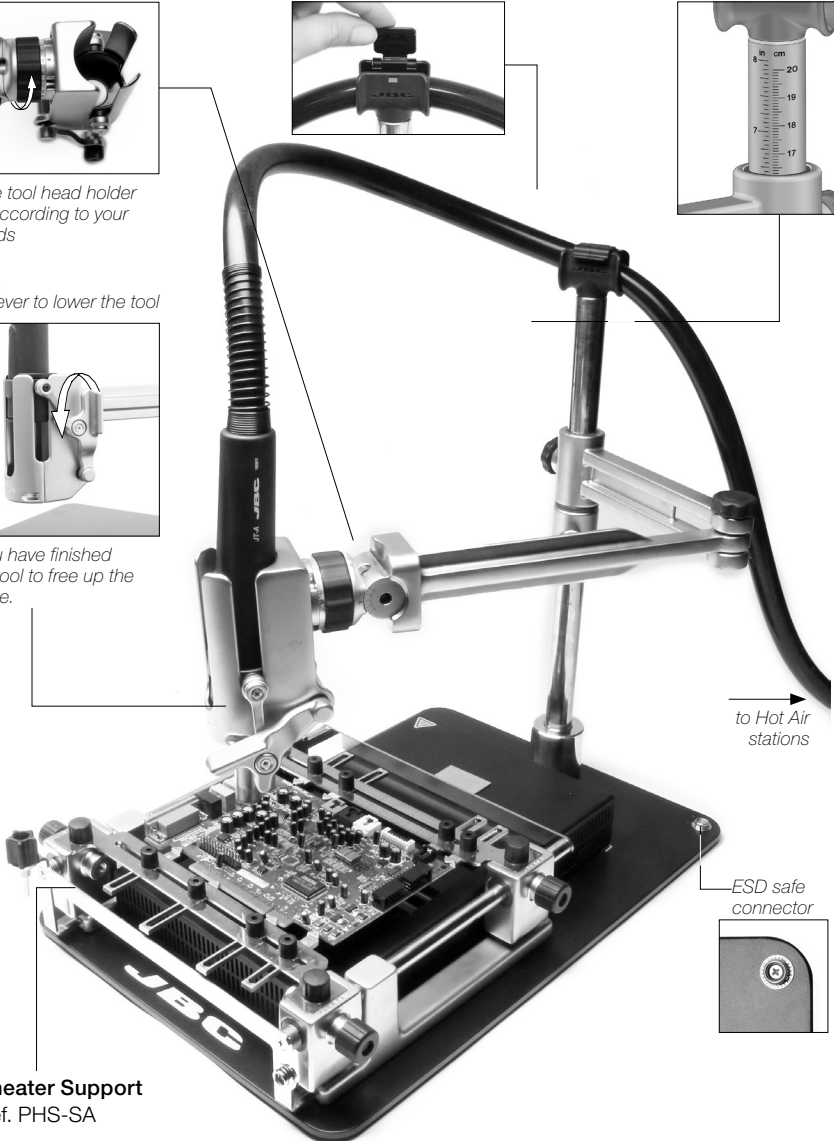

to Hot Air stations

ESD safe connector



IR Preheater Support
Ref. PHS-SA

Assembly

1. Setting up the Tool Arm

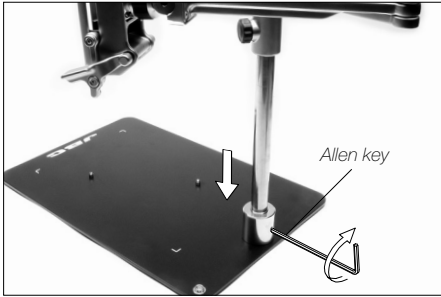

Fit the tool arm onto the base and tighten the screw.

2. Inserting the Adapter (JT/TE)

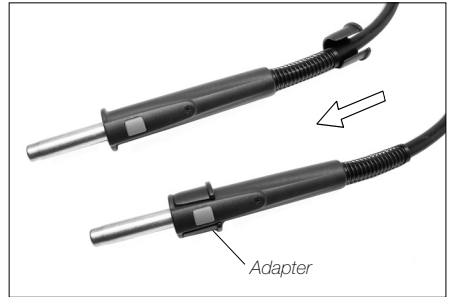

Slide the adapter along the hose to the end of the handle.

3. Mounting the Tool

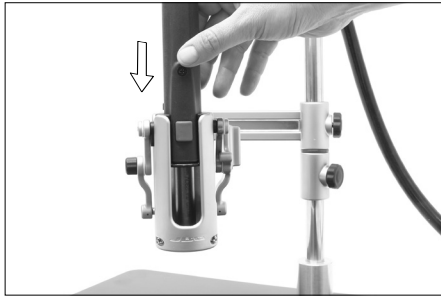

Insert the tool as far as possible.

4. Place the hose in the clamp.



Positioning PHS on RWS

The position of the PHS can be fixed on the RWS by means of positioning caps.

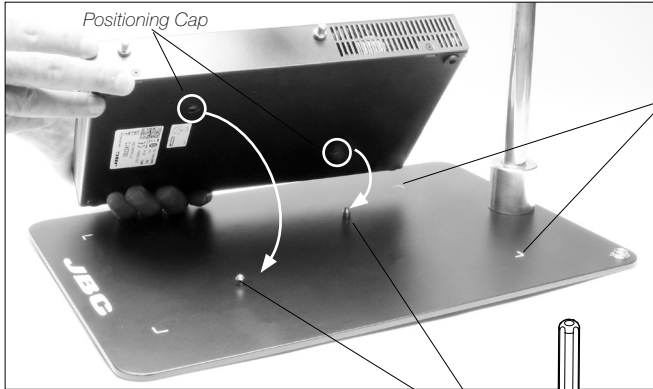

Fit the positioning cap into the positioning bolt.
The four corner guides helps to the placement of the Unit.

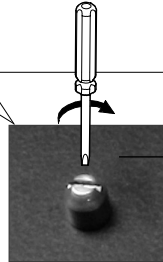

It can be removed with a screwdriver if fixed position is not wanted.

There are two possible PHS position.



Height Adjustment

The RWS-D Arm allows adjustment for different heights according to your work needs through the vertical axis rule.

Slide the tool holder to the appropriate height and secure by tightening the lower knob to guarantee stability. Make sure the upper knob is loosened before sliding the tool holder.

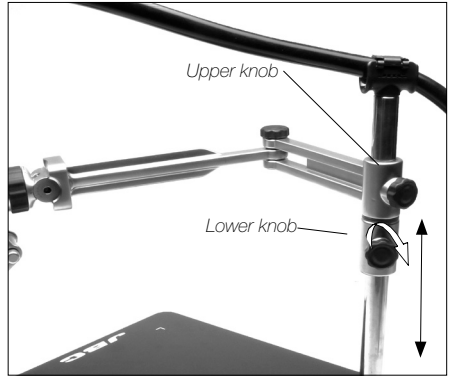

Work Position Adjustment

The RWS-D arm allows adjustment for different positions according to your work needs. The articulated arm covers all work areas.

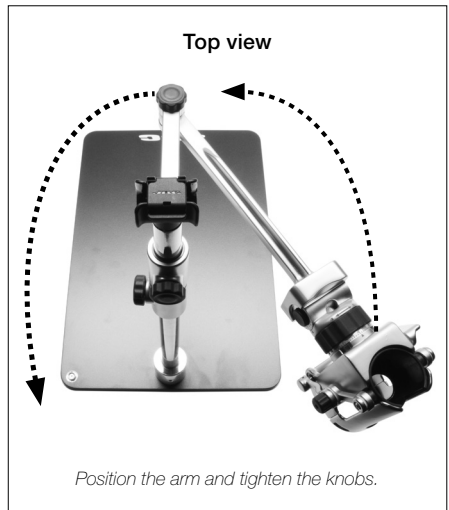

Tool Holder adjustment

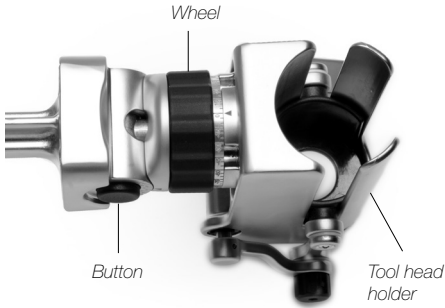

The Tool Holder for Rework Arm allows you to **adjust the tool head holder position** to suit your work needs.

Press the button or loosen the wheel to move the Tool Holder.

Both axes have a ruler to carry out the task with higher precision .

Tilting movement:



By holding down the button you can rotate the Tool Holder up or down.



The movement allows a rotation of -40° to $+40^{\circ}$.

Rotation movement:

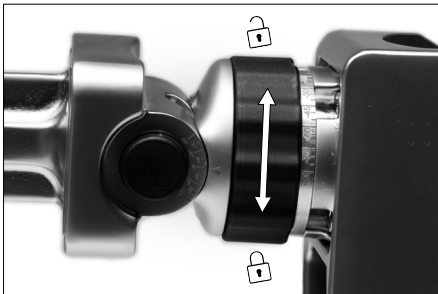

You can lock or unlock the lateral rotation mechanism by turning the fixing wheel a quarter.

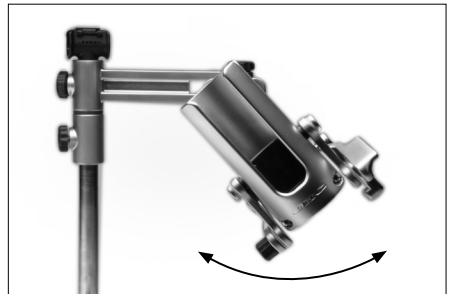

The movement allows a rotation of -90° a $+90^{\circ}$.

Maintenance

- Check periodically that the RWS-D is clean, especially the sliding parts and the shaft.
- Use a damp cloth when cleaning. Alcohol can only be used to clean the metal parts.
- Replace any defective or damaged parts. Use original JBC spare parts only.
- Repairs should only be performed by a JBC authorized technical service



Safety



It is imperative to follow safety guidelines to prevent electric shock, injury, fire or explosions.

- Do not use the equipment for any purpose other than PCB rework. Incorrect use may cause fire.
- The temperature of accessible surfaces may remain high after the unit is turned off. Handle with care.
- Be careful with the fumes produced when soldering.
- Keep your workplace clean and tidy. Wear appropriate protection glasses and gloves when working to avoid personal harm.
- Utmost care must be taken with liquid tin waste which can cause burns.
- This appliance can be used by children over the age of eight as well as persons with reduced physical, sensory or mental capabilities or lacking experience provided that they have been given adequate supervision or instruction concerning use of the appliance and understand the hazards involved. Children must not play with the appliance.
- Maintenance must not be carried out by children unless supervised.

Specifications

- Total weight: 5 kg (11. lb)
- Base dimensions: 270 x 410 mm (10.6 x 16.2 in)
- Height: 386,5 mm (15.2 in)
- Arm length: 444,5 mm (17.5 in)
- ESD safe connector

Complies with CE standards
ESD Safe

JBC

Warranty

JBC's 2 year warranty covers this equipment against all manufacturing defects, including the replacement of defective parts and labour.

Warranty does not cover product wear or misuse.

In order for the warranty to be valid, equipment must be returned, postage paid, to the dealer where it was purchased.

Register your warranty within 30 days of purchase in www.jbctools.com/productregistration



This product should not be thrown in the garbage.

In accordance with the European directive 2012/19/EU, electronic equipment at the end of its life must be collected and returned to an authorized recycling facility.

