

# JBC

www.jbctools.com

## INSTRUCTION MANUAL



## Hot Air Station without Extractor desk

Ref. JTSE-QA

# Packing List

The following items are included:

**JTSE Control Unit** .....1 unit  
 Ref. JTSE-1A (100V / 120V)  
 JTSE-2A (230V)



**Stand** .....1 unit  
 Ref. JT-SE



**Heater hose set** .....1 unit  
 Ref. JT-T1A (100V / 120V)  
 JT-T2A (230V)



**Thermocouple type K** .....1 unit  
 Ref. PH218



**Nozzles** ..... 1 unit  
 Ref. JN2015  
 JN2012  
 JN2020



**Kapton Tape** ..... 1 unit  
 Ref. PH217



**Power cable** .....1 unit  
 Ref. 0009417 (100V / 120V)  
 0009401 (230V)



**Manual** .....1 unit  
 Ref. 0018814



## Features



Thermocouple type K

Activates the suction pump

Suction Tube  
For tripods and extractors



USB-A connector

Heating element

Hot Air button  
(On / Off)

**Heater Hose set**  
Ref. JT-T1A (100V/120V)  
JT-T2A (230V)

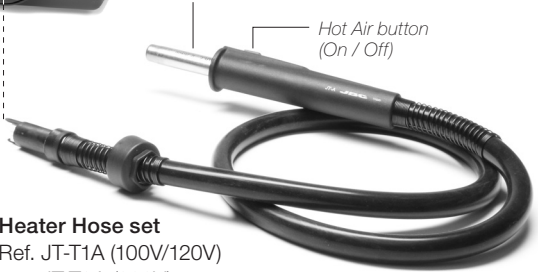

**Stand**  
Ref. JT-SE



Auxiliar connector

Equipotential connector

USB connector

Robot RS232 connector

Power Socket

Fuse

P-005 Pedal connector

# JTSE / TESE Work Screen

The JTSE/TESE offers an **intuitive user interface** which provides **quick access** to station parameters.  
**Default PIN: 0105**

The screenshot shows the JBC logo at the top. Below it is a status bar with a speaker icon, the time 17:14, and a status indicator. The main display area shows a vertical bar for 'Instant power supplied to heater' at 45%. The 'Hot Air Temp.' is 400°C, with '400°C Selected' below it. The 'Air Flow Selec.' is 80%, with '80%' displayed in large font. The 'TC Temp.' is 20°C, with '20°C Selected' below it. The 'Protection' is 120°C, with '120°C Selected' below it. A timer shows '4m 38s'. Labels on the left side point to: Status bar, Instant power supplied to heater, Current air temp., Air temp. selected, and Current External TC temp. Labels on the right side point to: Status indicator, Selected Air flow, and Selected External Tc temp.

The keypad includes a menu button (three horizontal lines), a plus sign (+), a minus sign (-), left and right arrow keys, and an OK button. An information button (letter 'i') is also present. A label 'Station Information' points to the information button.

## Menu Options



Set the station parameters

**Station**



Set the tool parameters

**Tools**



Display the hours worked in each cycle

**Counters**



It is possible to choose the language from a list.

**Language**



Allows you to carry out an overall station reset restoring all the parameters to their default values.

**Reset**

## Troubleshooting

Station troubleshooting available on the product page at [www.jbctools.com](http://www.jbctools.com)

## Advanced functionalities



### Profiles

To work with profiles it is essential to use the RWB / RWS / RWT rework arms. The Rework Arms supports the Hot Air Heater maintaining the distance and position to the component.

In this mode you can **set up or edit** as many as 25 profiles of temperature and air flow.

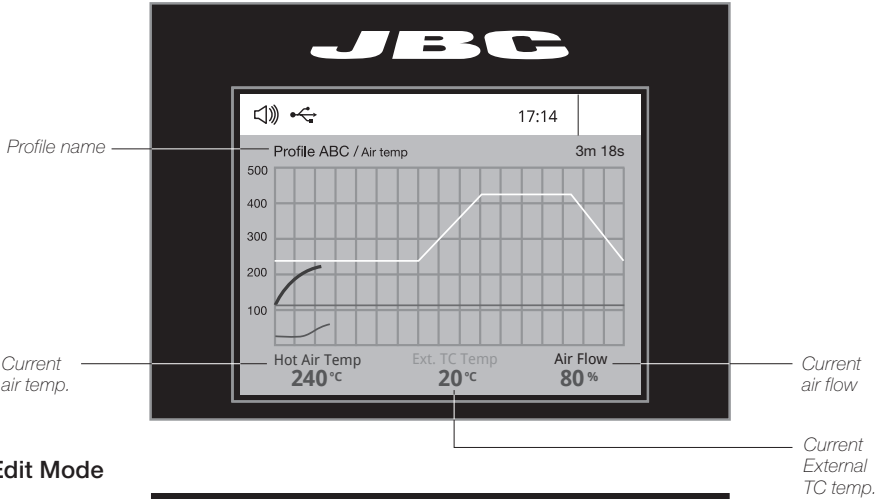

### Edit Mode

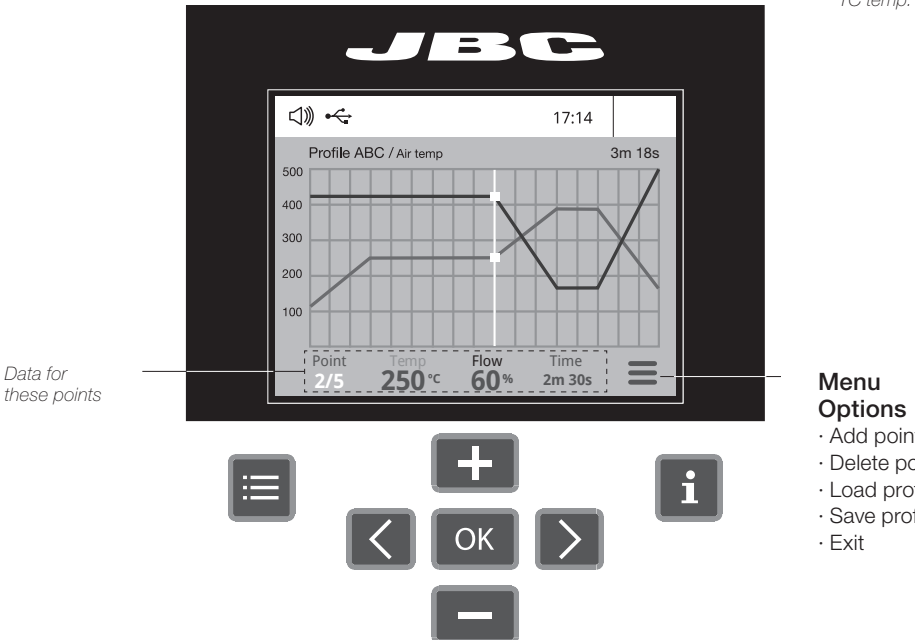



### Graphics

By pressing **Graphics** in the main MENU, temperature and power figures in real time are displayed. This helps you decide which tip to use to obtain the best quality solder joints.

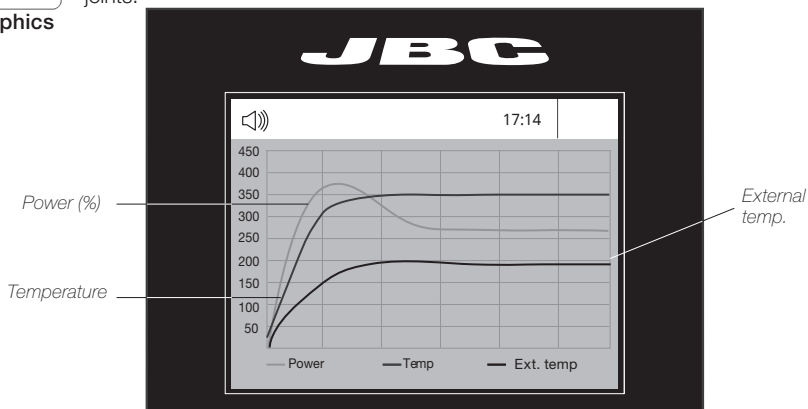

### The first system to optimize traceability in soldering

- Get greater quality and control in your production
- Manage your whole soldering process remotely in real time

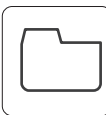

### Files

#### Export graphics

Insert a USB flash drive into the USB-A connector to save your soldering process in csv format.



### Update

#### Station update

Download the JBC Update File from [www.jbctools.com/software.html](http://www.jbctools.com/software.html)  
Insert the USB flash drive with the file downloaded to the station.



## System notifications

The following icons will be displayed on the screen's status bar.



USB flash drive is connected.



Station software update.  
Press INFO to start the process.



Station is controlled by a PC.



Warning.  
Press INFO for failure description.



Station is controlled by a robot.



Error.  
Press INFO for failure description, the type of error and how to proceed.

## Adjustable Stand

Adjust the tool holder angle to suit your work position.

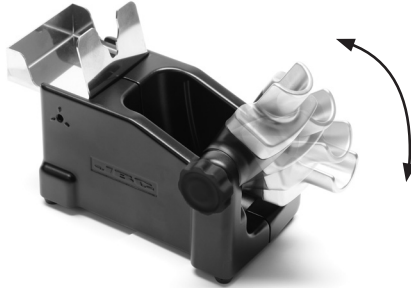

## Operation Modes

1. From the Tool Settings Menu, select the mode to activate the tool depending on the task.

### Tool button



Press the start/stop button to blow hot air.

### Pedal\*

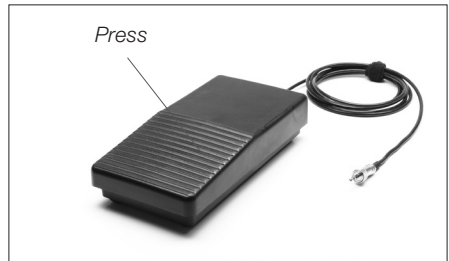

Press the Pedal to blow hot air and release to stop.

*\*The P-005 Pedal is not supplied with this station. See our website.*

2. The tool stops blowing when pressing the start/stop button.

If the stand is connected to the station and for safety it will also stop when returned to the stand.



# Operation

## 1. Placing

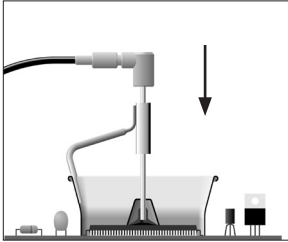

Position the extractor with the appropriate suction cup and press the suction button.

## 2. Heating

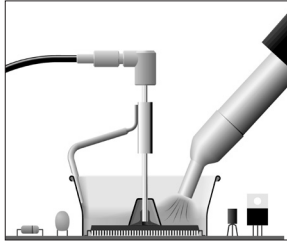

Heat the component.

## 3. Extracting

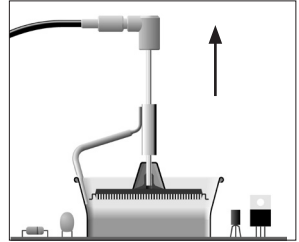

The component lifts off automatically when the solder melts.

# Protectors & Extractors

## For small components (fig. 1 and 2).

We recommend using the protector + tripod

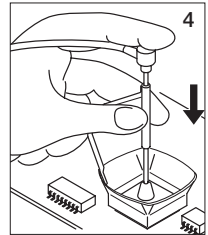
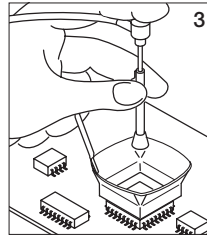
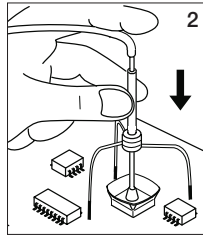
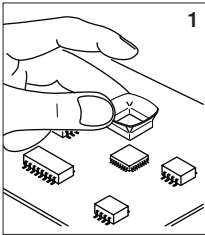

## For large components (fig. 3 and 4).

We recommend using the manual extractors



## Using the Thermocouple type K

Connect a TC type K (PH218) to the station and use it as a protection or regulation sensor. You can define its use mode by means of the “Ext TC mode” option in the “Tool” menu.

You can choose from **two work modes**:

**Regulation:** the station regulates the air temperature automatically to maintain the External Thermocouple (TC) temperature.

**Protection:** the station cuts the air supply off when the External Thermocouple (TC) temperature is reached.

*Fix the TC with Kapton Tape (Ref. PH217) as near as possible to the component being worked on. If Kapton tape is not ESD you must use an ionizer.*

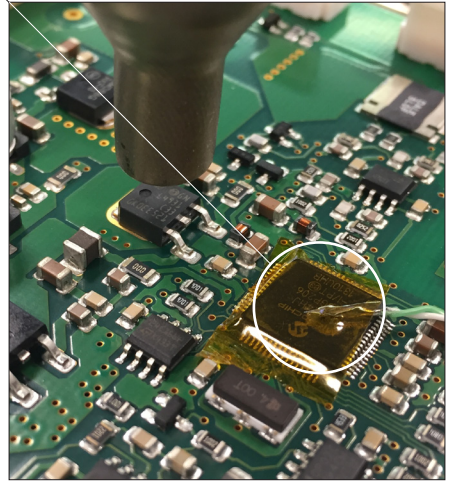
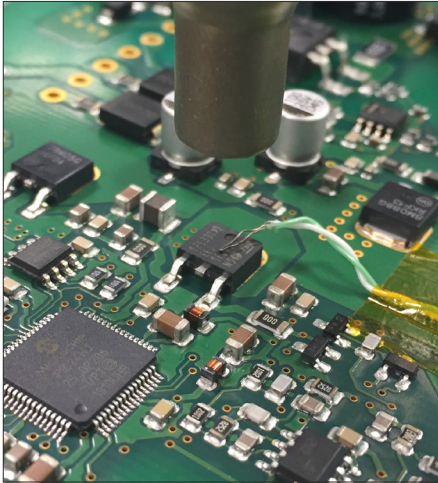

IPC\* does not recommend exceeding ramp-up rates over 3-4°C / sec. (5-7°F / sec) so as to reduce the risk of thermal stress on the PCB.

\* IPC was founded in the U.S. in 1957 as the Institute for Printed Circuits.

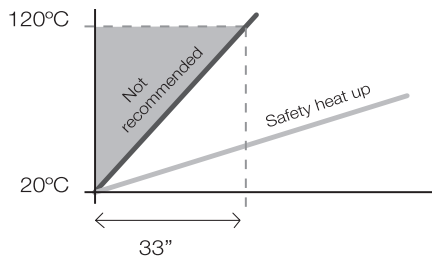

# Quick Nozzle Changer

Changing nozzles quickly and safely.

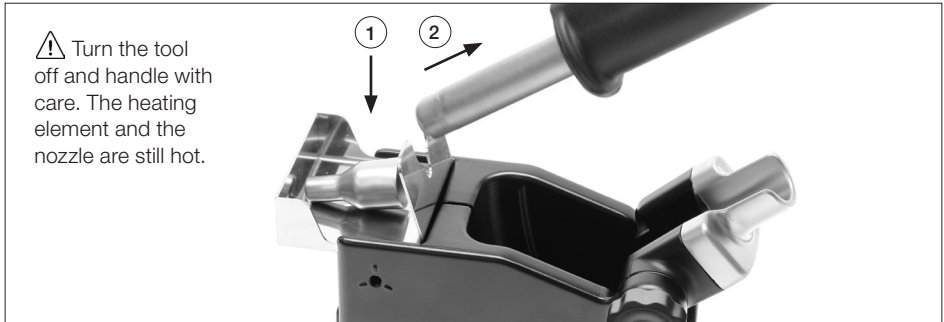

## Compatible Nozzles

The JT-TA works with JT nozzles. Find the model that best suits your soldering needs in [www.jbctools.com](http://www.jbctools.com)

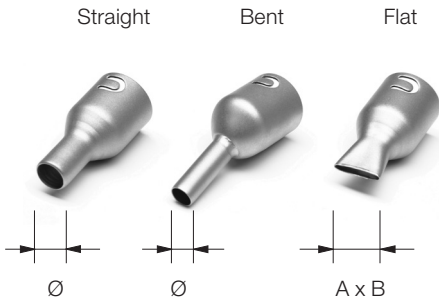

* Ref.	Shape	Ø Size (mm)	Ø Size (in)
JN2020	Straight	Ø 8	Ø 0.31
JN8417	Straight	Ø 10	Ø 0.4
JN2015	Bent	Ø 4	Ø 0.16
JN2012	Bent	Ø 6	Ø 0.24
JN6633	Bent	Ø 8	Ø 0.31
JN7637	Flat	10 x 2	0.4 x 0.08
JN7638	Flat	20 x 2	0.8 x 0.08
JN7639	Flat	30 x 2	1.18 x 0.08

*\* Not included*

In case of a loosely fitting nozzle:

1. Push the nozzle tab inwards with a screwdriver or flat-nosed pliers.

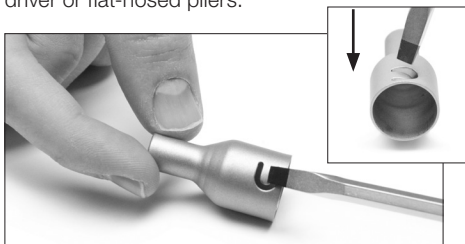

2. Insert the nozzle into the JT-TA again.

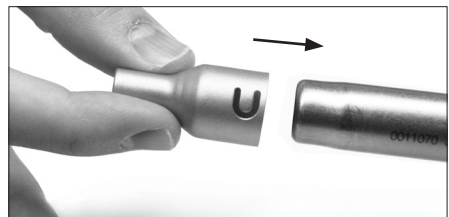

## Replacing the Heating Element

Only perform this operation when the element is cold and the unit is disconnected from the mains.

1. Loosen the screw.
2. Pull the heating element out of the handle.
3. Connect the new heating element, ensuring it is pushed all the way in.
4. Tighten the screw.

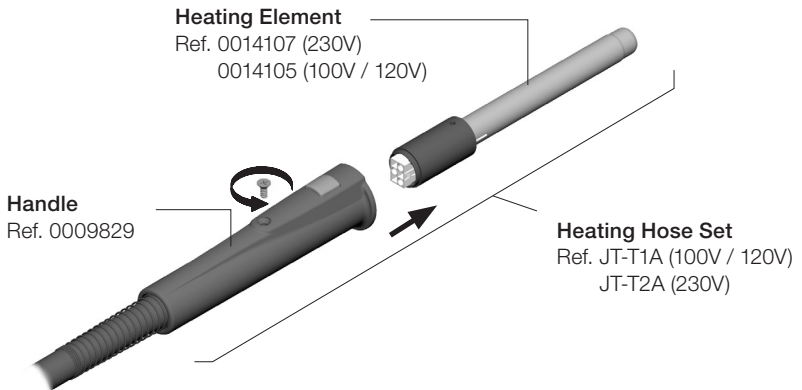

## Changing the JT-TA Heater Hose Set

1. Unplug the power cable.
2. Use a spanner to unscrew the nut.
3. Make sure that the new heater tube fits into the grooves in the socket.
4. Tighten the screw.

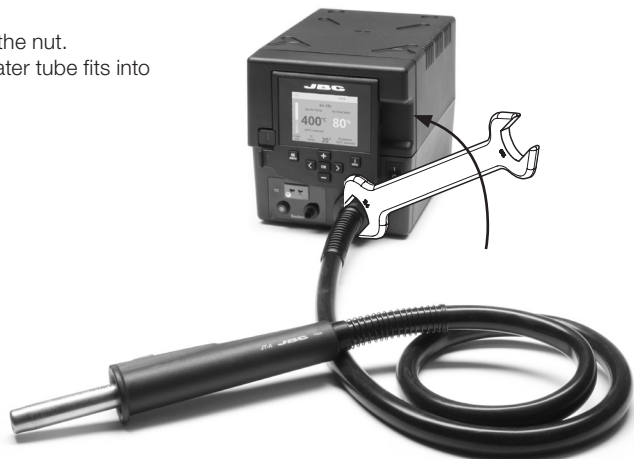

# Maintenance

Before carrying out maintenance, always allow the equipment to cool.

- Clean the station screen with a glass cleaner or a damp cloth.
- Use a damp cloth to clean the casing and the tool. Alcohol can only be used to clean the metal parts.
- Periodically check that the metal parts of the tool and stand are clean so that the station can detect the tool status.
- Periodically check all cables and tubes.
- Replace a blown fuse as follows:



1. Pull off the fuse holder and remove the fuse. If necessary use a tool to lever it off.

2. Insert the new fuse into the fuse holder and return it to the station.

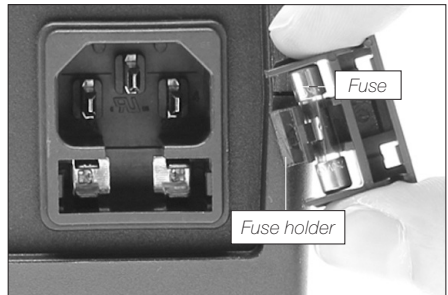
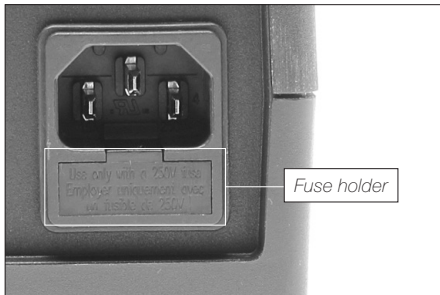

- Replace any defective or damaged pieces. Use original JBC spare parts only.
- Repairs should only be performed by a JBC authorized technical service.

## Safety



**It is imperative to follow safety guidelines to prevent electric shock, injury, fire or explosion.**

- Do not use the units for any purpose other than soldering or rework. Incorrect use may cause fire.
- The power cord must be plugged into approved bases. Be sure that it is properly grounded before use. When unplugging it, hold the plug, not the wire.
- Do not work on electrically live parts.
- The tool should be placed in the stand when not in use in order to activate the sleep mode. The soldering tip, the metal part of the tool and the stand may still be hot even when the station is turned off. Handle with care, including when adjusting the stand position.
- Do not leave the appliance unattended when it is on.
- Do not cover the ventilation grills. Heat can cause inflammable products to ignite.
- Avoid the contact of flux with skin or eyes to prevent irritation.
- Be careful with the fumes produced when soldering.
- Keep your workplace clean and tidy. Wear appropriate protection glasses and gloves when working to avoid personal harm.
- Utmost care must be taken with liquid tin waste which can cause burns.
- This appliance can be used by children over the age of eight and also persons with reduced physical, sensory or mental capabilities or lack of experience provided that they have been given adequate supervision or instruction concerning use of the appliance and understand the hazards involved. Children must not play with the appliance.
- Maintenance must not be carried out by children unless supervised.

# 有害物质含量表

产品中有害物质的名称及含量

部件名称	有害物质					
	铅(Pb)	汞(Hg)	镉(Cd)	六价铬(Cr(VI))	多溴联苯(PBB)	多溴二苯醚(PBDE)
烙铁头	○	○	○	○	○	○
手柄	○	○	○	○	○	○
电源线	○	○	○	○	○	○
主机	○	○	○	○	○	○
电源插座	○	○	○	○	○	○
保险丝	○	○	○	○	○	○
主开关	○	○	○	○	○	○
电位连接	X	○	○	○	○	○
变压器	○	○	○	○	○	○
线路板	X	○	○	○	○	○

○ 表示该有害物质在该部件所有均质材料中的含量均在GB/T 26572 规定的限量要求以下。  
X 表示该有害物质至少在该部件的某一均质材料中的含量超出GB/T 26572 规定的限量要求。

## Specifications

**JTSE-1A** 100V - 120V 50/60Hz. Input fuse: 8A. Rated current: 7A

**JTSE-2A** 230V 50/60Hz. Input fuse: 4A. Rated current: 3A

- Temperature selection: Room temp. / 150 - 450 °C (300 - 840 °F)
- Nominal power: 700W
- Cool mode: T off. Used to blow air at room temperature
- Ambient operating temp.: 10 - 50 °C (50 - 122 °F)
- Air flow regulation: 5 - 50 SLPM
- Vacuum: 30% / 228 mmHg / 9 inHg
- Connectors: USB-A / USB-B  
RJ12 for RS232  
Pedal for P-005
- Control Unit Weight: 1,9 kg (10.86 lb)
- Control Unit Dimensions: 148 x 184 x 140 mm (5.83 x 7.24 x 5.51 in)
  
- Total Package: 474 x 368 x 195 mm / 4,62 kg  
18.7 x 14.5 x 7.7 in / 10.2 lb

Complies with CE standards.  
ESD protected.

# JBC

---

## Warranty

JBC's 2 year warranty covers this equipment against all manufacturing defects, including the replacement of defective parts and labour.

Warranty does not cover product wear or misuse.

In order for the warranty to be valid, equipment must be returned, postage paid, to the dealer where it was purchased.

**Get 1 extra year JBC warranty by registering here:**  
<https://www.jbctools.com/productregistration/>  
**within 30 days of purchase.**

---



This product should not be thrown in the garbage.

In accordance with the European directive 2012/19/EU, electronic equipment at the end of its life must be collected and returned to an authorized recycling facility.



[www.jbctools.com](http://www.jbctools.com)

0018814-0120